

LINEAR 18/10 STAINLESS STEEL INSET SINK

LR950/TCAF1



Size: 950 x 508 mm

The Linear collection is a popular range thanks to its versatile styling, the design features classic lines paired with soft bowls. The Linear collection is available in an array of sizes, finishes and bowl configurations, offering a solution for every installation.

- Complete pack: includes sink, tap and compatible waste kit
- Fits a 500mm cabinet
- Sink features a reversible drainer in a satin/bright finish
- Sink is manufactured from 18/10 stainless steel
- Single lever tap in chrome finish
- WRAS approved tap
- Reduced waste and overflow kit included
- 10 year warranty for sink, 5 year warranty for tap

Material	18/10 Stainless Steel
Material Gauge	0.6
Material Finish Bowl	Satin
Material Finish Drainer	Bright
Drainer Position	Reversible
Overall Length (mm)	950
Overall Width (mm)	508
Main Bowl Length (mm)	420
Main Bowl Width (mm)	350
Main Bowl Depth (mm)	160
Second Bowl Length (mm)	-
Second Bowl Width (mm)	-
Second Bowl Depth (mm)	-
Tap hole Size (mm)	1 x 35
Waste Size (mm)	1 x 52
Waste Kit:	Included with sink (1 x 60mm waste & overflow kit)
Min. Base Unit (mm)	500
Cutout Size Length (mm)	930
Cutout Size Width (mm)	488
Warranty Sinks (years)	10
Product Code	LR950/TCAF1
Barcode	5015834042770

Date of download: May 13, 2021

AGA Rangemaster continuously seeks improvements in specification, design and production of products and thus, alterations take place periodically. Whilst every effort is made to produce up to date resources, the information included here is intended as a guide. Always refer to the installation instructions when fitting, installation work should be completed by a professional tradesman.

LINEAR 18/10 STAINLESS STEEL INSET SINK

LR950/TCAF1

Technical Drawing

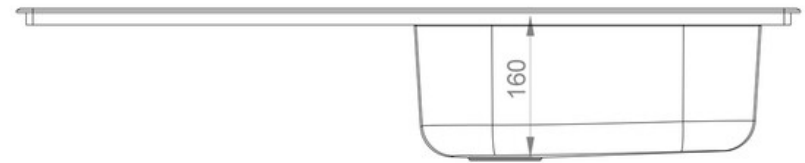
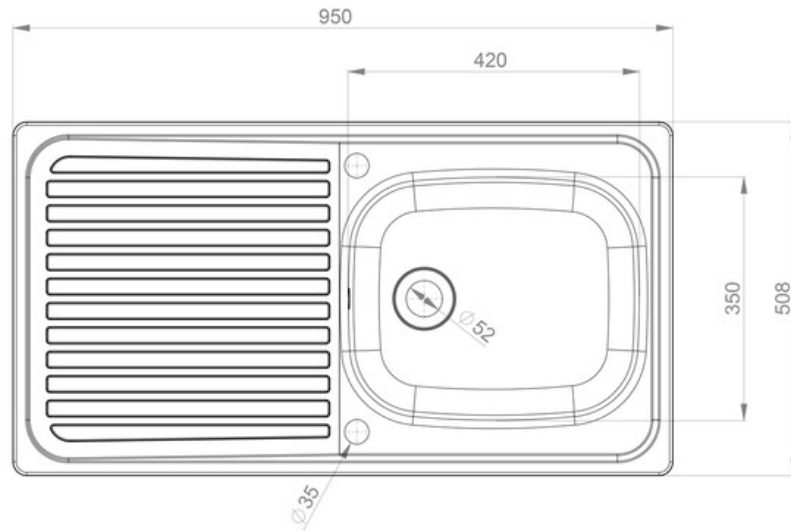

Date of download: May 13, 2021

AGA Rangemaster continuously seeks improvements in specification, design and production of products and thus, alterations take place periodically. Whilst every effort is made to produce up to date resources, the information included here is intended as a guide. Always refer to the installation instructions when fitting, installation work should be completed by a professional tradesman.

LINEAR 18/10 STAINLESS STEEL INSET SINK

LR950/TCAF1

Cut Out Template
Dimensions in mm. Not to scale.

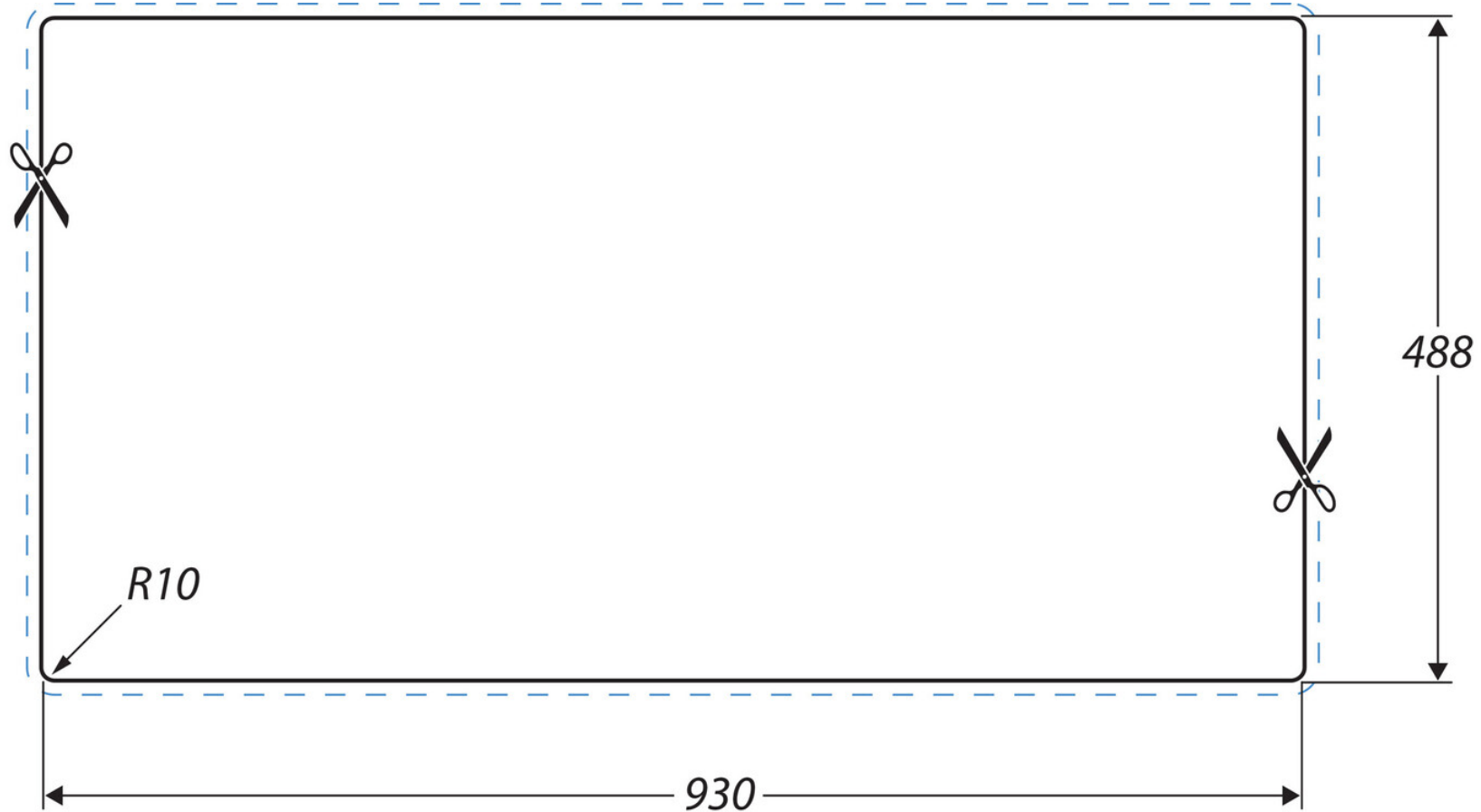

Date of download: May 13, 2021

AGA Rangemaster continuously seeks improvements in specification, design and production of products and thus, alterations take place periodically. Whilst every effort is made to produce up to date resources, the information included here is intended as a guide. Always refer to the installation instructions when fitting, installation work should be completed by a professional tradesman.