

LUXE 18/10 STAINLESS STEEL INSET SINK LX84/



Size: 2120 x 460 mm

The Luxe collection offers an array of polished options to choose from in several different lengths including double drainer options and double bowl options.

- Double drainer
- Polished finish
- Manufactured from 18/10 stainless steel
- 10 year warranty

Waste kit included.

Material
Material Gauge
Material Finish Bowl
Material Finish Drainer
Drainer Position
Overall Length (mm)
Overall Width (mm)
Main Bowl Length (mm)
Main Bowl Width (mm)
Main Bowl Depth (mm)
Second Bowl Length (mm)
Second Bowl Width (mm)
Second Bowl Depth (mm)
Tap hole Size (mm)
Waste Size (mm)
Waste Kit:
Min. Base Unit (mm)
Cutout Size Length (mm)
Cutout Size Width (mm)
Warranty Sinks (years)
Product Code
Barcode

LUXE 18/10 STAINLESS STEEL INSET SINK

LX84/

Technical Drawing

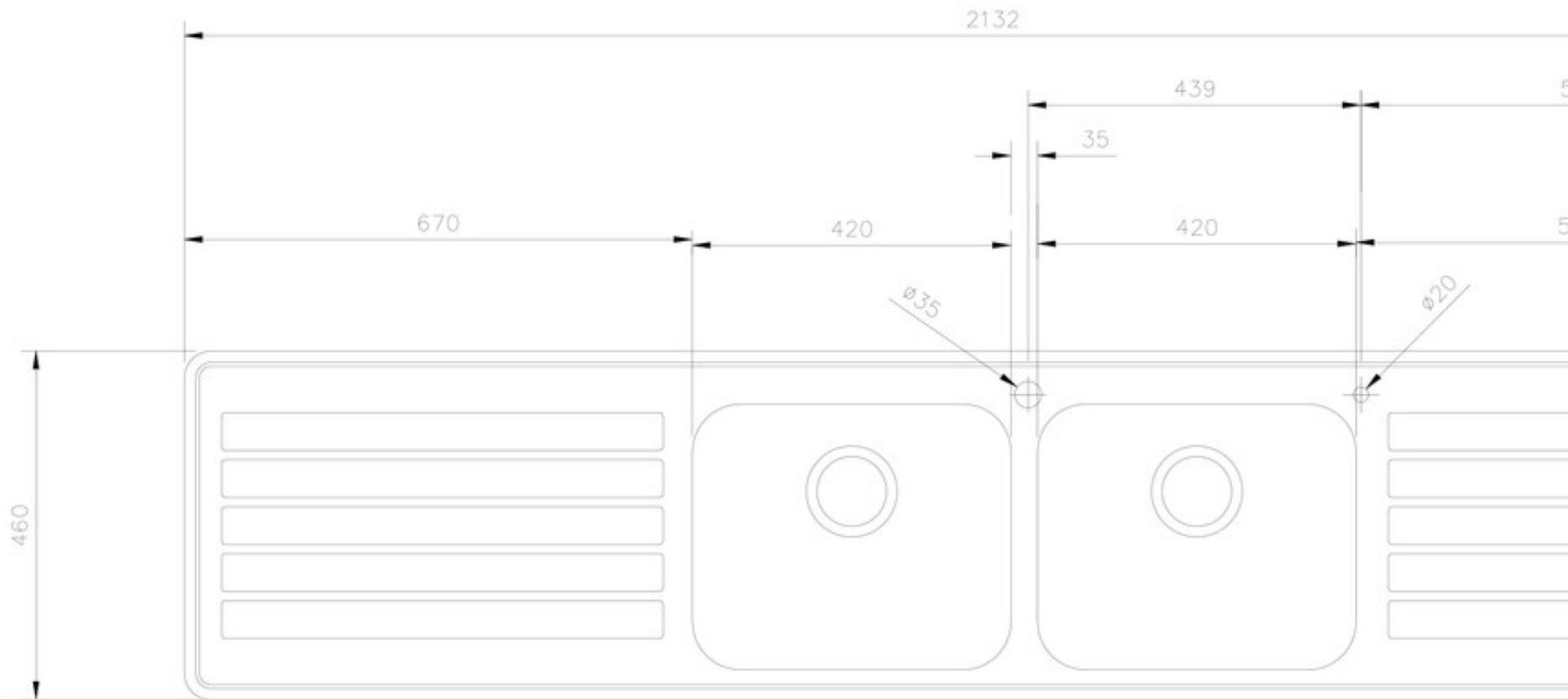

AGA Rangemaster continuously seeks improvements in specification, design and production of products and thus, alterations take place periodically. Whilst every effort is made to produce up to date resources, the information included here is intended as a guide. Always consult a tradesman.

LUXE 18/10 STAINLESS STEEL INSET SINK LX84/

Cut Out Template
Dimensions in mm. Not to scale.

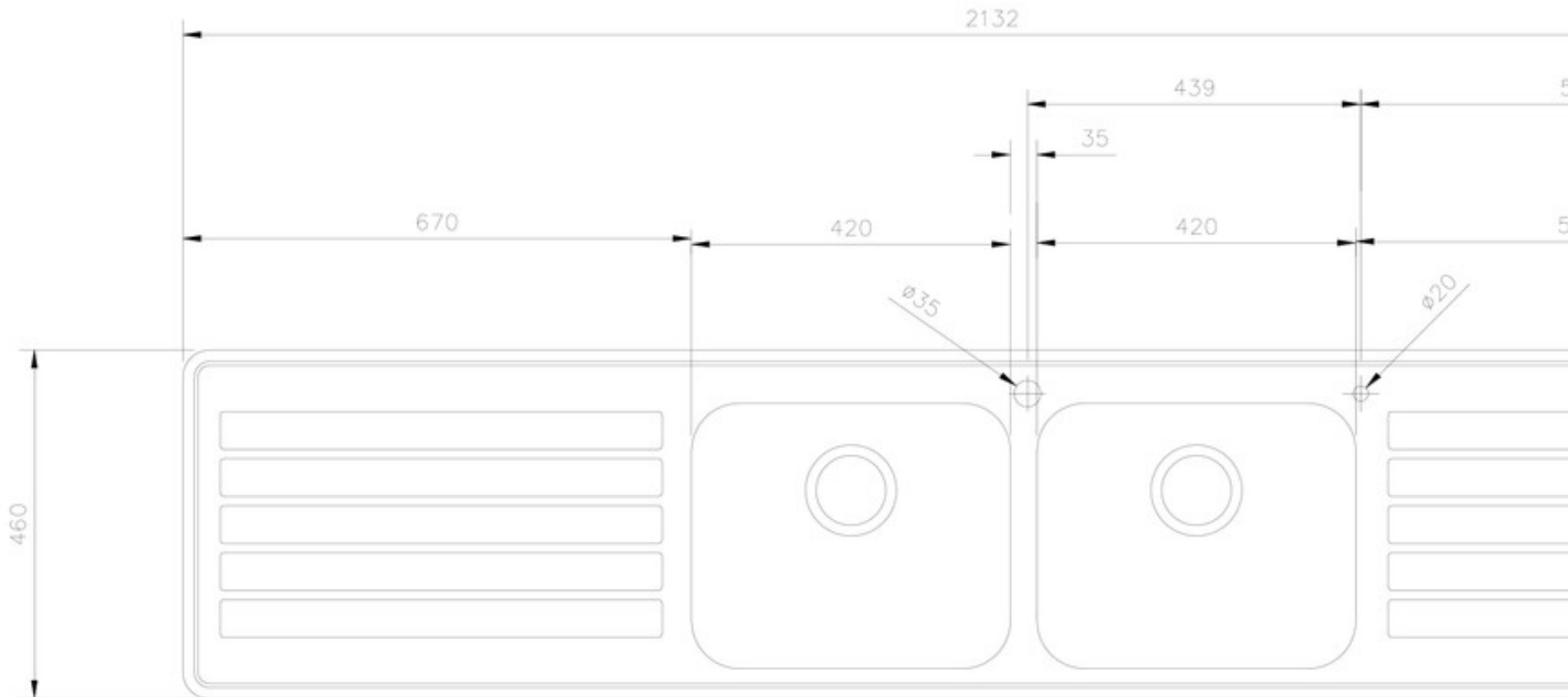

AGA Rangemaster continuously seeks improvements in specification, design and production of products and thus, alterations take place periodically. Whilst every effort is made to produce up to date resources, the information included here is intended as a guide. Always consult a tradesman.